

CUE2015-Applied Energy Symposium and Summit 2015: Low carbon cities and urban energy systems

## Analytical Models of Power Losses of a Three phase AC-DC Rectifier for Hybrid Electric Vehicles

Z. Xu<sup>a,\*</sup>, K. You<sup>a</sup>, C. Zhang<sup>b</sup>

<sup>a</sup>The University of Nottingham, China campus, 199 Taikang East Road, Ningbo, 315100, China

<sup>b</sup>State Grid Electric Power Research Institute (SGEPRI)

### Abstract

This paper presents the investigation of analytical models for the approximation of conduction and switching losses of the power-switch network in a three-phase AC-DC matrix rectifier. Analytical models of conduction and switching losses can provide circuit designers with a measurable way to approximate the total losses of the given power converter at different operating points so as to estimate the trend of the loss versus the change of the operating points.

© 2016 The Authors. Published by Elsevier Ltd. This is an open access article under the CC BY-NC-ND license (<http://creativecommons.org/licenses/by-nc-nd/4.0/>).

Peer-review under responsibility of the organizing committee of CUE 2015

*Keywords:* Conduction and switching losses; Three-phase AC-DC matrix rectifier; Analytical models

### 1. Introduction

Normally, a complete model for either conduction or switching loss of a given semiconducting device involves many variables capturing steady-state and transient behaviors. In order to study the relation between the power loss and the operating principles of a given topology, it is desirable to calculate the power loss simply based on the variables, such as voltage, current, and switching frequency, which is predictable from the operating principles of the given topology. When the thermal transient behavior is ignored (which is reasonable for the approximation of power loss), the conduction loss at certain junction temperature can be calculated by average R.M.S. current and average current through the target

\* Corresponding author. Tel.: +86-0574-88189135; fax: +86-0574-88180175.

E-mail address: [zhuang.xu@nottingham.edu.cn](mailto:zhuang.xu@nottingham.edu.cn).

semiconductor. The On-state parameters at that junction temperature can be found in the relevant datasheet.

However, for the approximation of the switching loss, the switched voltage,  $u$ , and the switched current,  $i$ , are not sufficient for the datasheet-based calculation due to the requirement of many quantities involved in the switching behavior. An effective way to enable the calculation using  $u$  and  $i$  with sufficient accuracy is the measurement-based approximation. That is to work out a model by using the measured switching loss and the corresponding  $u$  and  $i$  at a specified junction temperature. The experimental work reported in [1] is one case of this approach. The switching model of a specific IGBT and free-wheeling diode was obtained by quadratic least-square approximation from the measured data. Nevertheless, the exciting solutions to the approximation of the conduction and switching losses are not able to predict the trends of losses against various operating points fully. In the following analysis, the On-state parameters of the same semiconductors in [1] are used. The junction temperature is assumed to be at 120°C.

### 2. Switching Loss Approximation

The energy loss  $w$  of one single switching action has dependency on switched voltage  $u$  and current  $i$ . It is approximated by using (1), (2) and (3) [1]:

$$w_{Toff} = K_{Toff1}ui + K_{Toff2}ui^2 + K_{Toff3}u^2 + K_{Toff4}u^2i + K_{Toff5}u^2i^2 = w_{Toff}(u, i) \tag{1}$$

$$w_{Ton} = K_{Ton1}ui + K_{Ton2}ui^2 + K_{Ton3}u^2 + K_{Ton4}u^2i + K_{Ton5}u^2i^2 = w_{Ton}(u, i) \tag{2}$$

$$w_{Doff} = K_{Don1}ui + K_{Don2}ui^2 + K_{Don3}u^2 + K_{Don4}u^2i + K_{Don5}u^2i^2 = w_{Doff}(u, i) \tag{3}$$

where,  $u$  and  $i$  are switched voltage and current respectively; T and D denote IGBT and diode respectively;  $K_i$  is IGBT switching loss parameter as in Table 1. The turn-on switching loss of diode is ignored.

Table.1 Coefficients of the least-square approximation of the measured IGBT/free-wheeling diode switching losses at 120°C junction temperature ( $T_j$ )

$T_j$		$K1$	$K2$	$K3$	$K4$	$K5$
120°C	$T_{off}$	179	-1.31	0.650	-0.116	0.00348
	$T_{on}$	70.0	2.94	0.518	0.102	0.00155
	$D_{off}$	97.7	-3.73	0.488	0.140	0.00427
Units		nWs(VA) <sup>-1</sup>	nWs(VA <sup>2</sup> ) <sup>-1</sup>	nWs(V <sup>2</sup> ) <sup>-1</sup>	nWs(V <sup>2</sup> A) <sup>-1</sup>	nWs(V <sup>2</sup> A <sup>2</sup> ) <sup>-1</sup>

### 3. Conduction Loss Approximation

The IGBT or diode is modeled as a series connected voltage source  $V_{T/D}$  and resistor  $r_{D/T}$ , shown in Figure 1; T and D denote IGBT and free-wheeling diode respectively. The tested parameters reported in [1] are listed in Table 2;  $r_T$  is on-state resistance of IGBT;  $r_D$  is on-state resistance of freewheeling-diode;  $V_T$  is voltage drop of IGBT;  $V_D$  is forward voltage drop of freewheeling-diode.

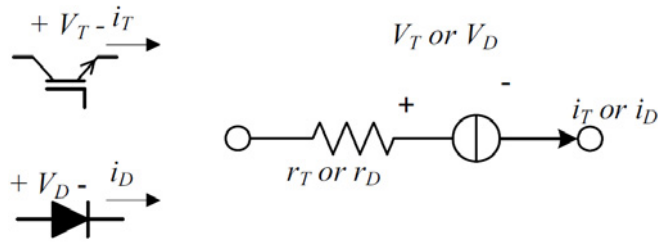

Fig. 1. IGBT and free-wheeling diode equivalent circuit for calculating the conduction loss

Table.2 Tested IGBT and free-wheeling diode on-state parameters at 120°C of junction temperature

$T_j$	$r_T$	$r_D$	$V_T$	$V_D$
120°C	0.0787	0.038	0.768	0.732
Units	V/A	V/A	V	V

The switch devices under discussion are gated on/off by ideal PWM signals. The conduction loss within every switching cycle can be approximated as given by

$$P_c = r_{T/D} i_{T/Drms}^2 + v_{T/D} \langle i_{T/D} \rangle \tag{4}$$

where,  $i_{T/Drms}$  is the R.M.S. current within switching cycle;  $\langle i_{T/D} \rangle$  is the average current within switching cycle.

#### 4. CONDUCTION AND SWITCHING LOSSES of an AC-DC MATRIX CONVERTER

The overall structure of the AC-DC matrix converter [2] is shown in Figure 2.

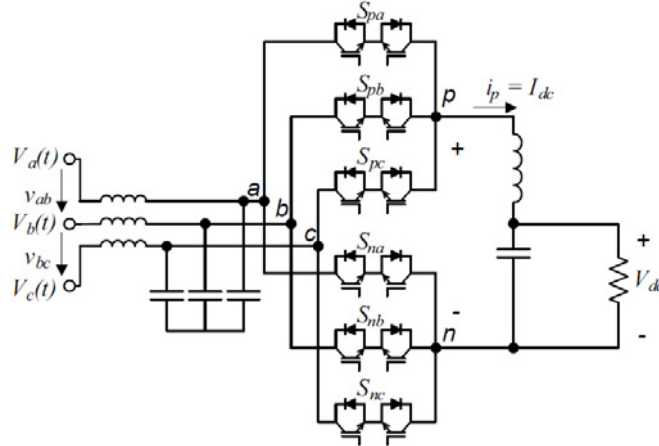

Fig. 2. Basic structure of AC-DC matrix converter used in MZC when MZC is in AC-DC rectification

The mathematical model can be expressed by equation (5)-(6).

$$\begin{bmatrix} V_{dcg} / 2 \\ -V_{dcg} / 2 \end{bmatrix} = \begin{bmatrix} d_{pa}(t) & d_{pb}(t) & d_{pc}(t) \\ d_{na}(t) & d_{nb}(t) & d_{nc}(t) \end{bmatrix} \begin{bmatrix} V_a(t) \\ V_b(t) \\ V_c(t) \end{bmatrix} \tag{5}$$

$$\begin{bmatrix} I_a(t) \\ I_b(t) \\ I_c(t) \end{bmatrix} = \begin{bmatrix} d_{pa}(t) & d_{na}(t) \\ d_{pb}(t) & d_{nb}(t) \\ d_{pc}(t) & d_{nc}(t) \end{bmatrix} \begin{bmatrix} I_{dc} \\ -I_{dc} \end{bmatrix} \tag{6}$$

$$M = \frac{4 V_{dc}}{3 V_{il-lg}} \tag{7}$$

$$0 < M < 2/\sqrt{3} \tag{8}$$

Where M is modulation ratio;  $V_{dc}$  is the output DC voltage;  $V_{il-lg}$  is the peak AC line voltage;  $\omega$  is the angular frequency of AC input.  $V_{in}$  and  $I_{in}$  stand respectively for the phase voltage peak and current peak;  $V_{dc}$  and  $I_{dc}$  are the output DC voltage and DC current.

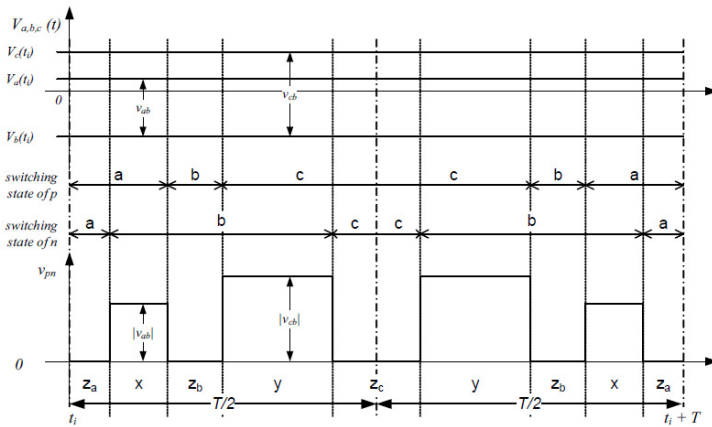

Figure 3 One instance of switching states produced by AV-optimum PWM

Figure 3 indicates that there are four commutations in one switching period for one output phase and that the sequence of the commutations is in the way of “a->b->cc->b->a”; They are helpful for working out the switching loss model of AC-DC matrix converter. The basic condition for the following discussion is that the sequence of current commutation is in the way of “a->b->cc->b->a” all the time, and that the four-step current commutation method is used. The AC source is assumed three-phase balanced voltage source. The load is resistive load. Gate-drives for individual switches are assumed ideal and lossless. The input/output voltages are far higher than the forward voltage drop of IGBT or free-wheeling diode, with which the switching action is treated as zero-voltage turn-on/off. Neither zero-current turn-on/off nor zero-voltage turn-on/off contributes to switching loss.

In addition, the given power factor is  $0.7 < pf < 0.9$ , the modulation ratio  $0.5 < M < 1.155$ , the switching frequency  $f_{sw}=10\text{kHz}$ , the DC input voltage  $V_{dc} = 42\text{V}$ , and the active power  $P_0 = 2000\text{W}$ .

According to the various parameters given, the conduction loss, switching loss and total losses can be calculated respectively:

$$P_{mc,c} = 2[(V_T + V_D)I_{dc} + (r_T + r_D)I_{dc}^2] \tag{9}$$

$$P_{mc,sw} = f_{sw} \left[ \frac{2.12K_3V_{dc}^2}{3/4M^2} + I_{dc} \left( \frac{1.91K_1V_{dc}}{\sqrt{3}/2M} + \frac{2.12K_4V_{dc}^2}{3/4M^2} \right) + I_{dc}^2 \left( \frac{1.91K_2V_{dc}}{\sqrt{3}/2M} + \frac{2.12K_5V_{dc}^2}{3/4M^2} \right) \right] \tag{10}$$

$$P_{mc-acdc} = P_{mc,c} + P_{mc.sw} \tag{11}$$

According to the given values of the parameters, the calculated results are shown in Figure 4-9.

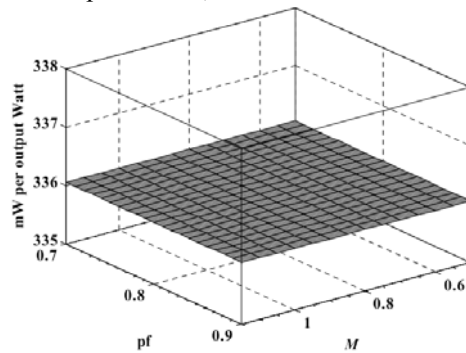

Fig.4 Conduction loss of AC-DC matrix converter when Vdc = 42V

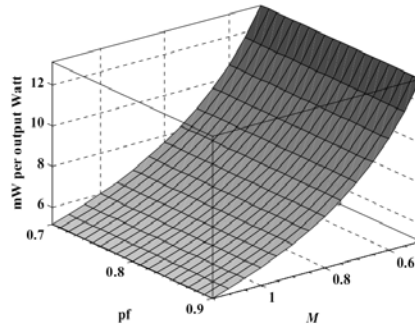

Fig.5 Switching loss of AC-DC matrix converter when Vdc = 42V

Figure 4,5,6 show the visual calculated results when the data in Table 1 are used. Table 2. Figure 7, 8, 9 show the visual calculated results when the DC voltage rises from 42V up to 200V under the conditions mentioned above. It can be seen from Figure 9 that conduction losses decline sharply when the DC voltage rises. The resulting increase in switching losses is much smaller than the reduction in conduction losses.

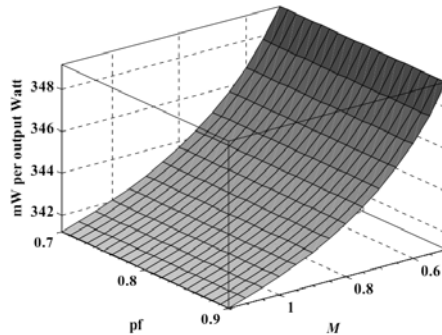
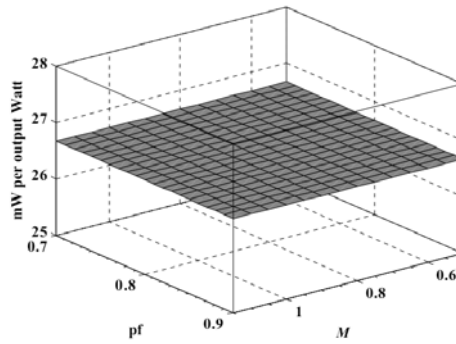
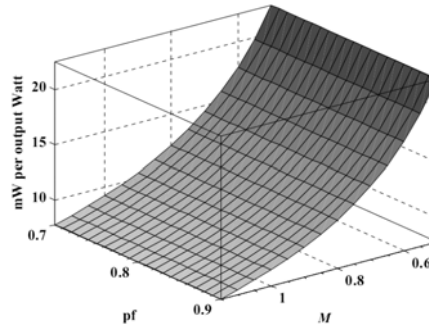
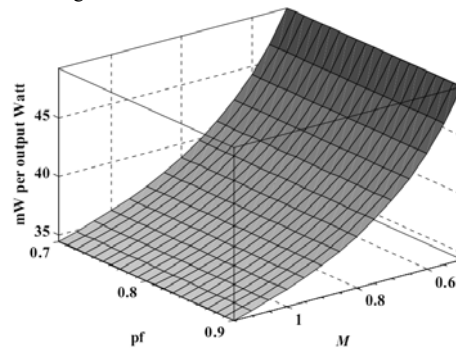

Fig.6 Total loss of AC-DC matrix converter when Vdc = 42V

Fig.7 Conduction loss of AC-DC matrix converter when  $V_{dc} = 200V$ Fig.8 Switching loss of AC-DC matrix converter when  $V_{dc} = 200V$ Fig.9 Total loss of AC-DC matrix converter when  $V_{dc} = 200V$ 

## Conclusions

Investigation of the conduction and switching losses is one of the fundamental requirements in the thermal design of any power converter. The analytical models for the approximation of the conduction and switching losses of the power-switch network in the proposed AC-DC matrix rectifier have been investigated.

Authors keep full copyright over papers published in Energy Procedia

### Acknowledgements

The authors would like to thank Ningbo Science and Technology Bureau for the financial support of this very interesting project (2014A610146).

### References

[1] Schafmeister, F., Herold, S., Kolar, J.W., "Evaluation of 1200 V-Si-IGBTs and 1300 V-SiC-JFETs for application in three-phase very sparse matrix AC-AC converter systems," Applied Power Electronics Conference and Exposition, 2003. APEC '03. Eighteenth Annual IEEE, Volume 1, 9-13 Feb. 2003 Page(s):241 - 255 vol.1.

[2] Keping You; Dan Xiao; Rahman, M.F.; Uddin, M.N., "Applying Reduced General Direct Space Vector Modulation Approach of AC-AC Matrix Converter Theory to Achieve Direct Power Factor Controlled Three-Phase AC-DC Matrix Rectifier," Industry Applications, IEEE Transactions on , vol.50, no.3, pp.2243,2257, May-June 2014



#### Biography

Dr Zhuang Xu works with the University of Nottingham Ningbo China. Zhuang Xu received his Ph.D. degree in electrical engineering from the University of New South Wales, Sydney, Australia. His research has been focused on power electronics and high performance electrical drives.